

SLA

FACTORY ACTIVATED

SLA | READY TO START

REF BTZ7S



12V VOLTAGE - V

130A CCA - A

6.3Ah CAPACITY - Ah (20Hr)

6Ah CAPACITY - Ah (10Hr)

TECHNOLOGY

- Designed according to AGM technology (Absorbed acid)
- VRLA battery type
- Activated and pre-charged batteries
- Homologated by OEM

FEATURES

- AGM construction (Absorbed Glass Material)
- VRLA battery (Valve Regulated Lead Acid)
- Factory activated
- Environmentally friendly, spillproof design
- Multi-positional fitment
- Absolutely Maintenance free
- Sealed, no gas emission through venting hole (under normal operation)
- Ready & Easy to use
- No acid handling - Very safe
- Increased power & Extended life
- Extreme vibration resistance

UPGRADE FOR

WEIGHT

Battery (with acid) : Approx 2.08kg (4.58lbs)

MOUNTING ANGLE

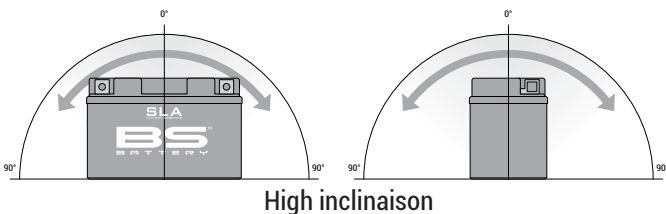

DIMENSIONS

Length (A) : 113±2mm (4.45in)
 Width (B) : 70±2mm (2.76in)
 Container height : 105±2mm (4.13in)
 Total height (C) : 105±2mm (4.13in)

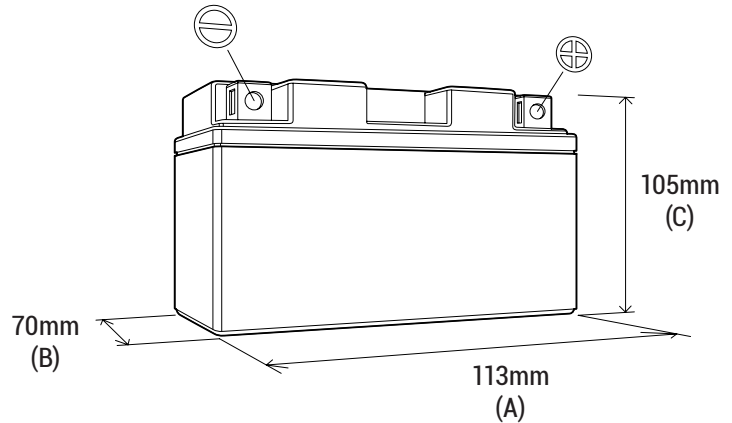

TERMINALS

