

## MF BATTERY

MF | MAINTENANCE FREE

# REF BT7B-BS



**12V** VOLTAGE - V

**85A** CCA - A

**6.8Ah** VOLTAGE - Ah (20Hr)

**6.5Ah** VOLTAGE - Ah (10Hr)

### TECHNOLOGY

- AGM construction (absorbed acid)
- VRLA battery (Valve Regulated Lead Acid)
- Supplied with a separate acid pack
- Homologated by OEM

### FEATURES

- Upright installation only
- Maintenance free (no water refilling)
- Sealed after filling, no gas emission through venting hole (under normal operation)
- High power
- Does not need to be recharged while stocked
- Suitable for cold weather
- Reduction of plate sulfation
- Higher life cycle (up to three times longer than conventional batteries)
- Longer voltage hold

### UPGRADE FOR

-

### WEIGHT

Battery (with acid) : Approx 2.34kg (5.15lbs)

### MOUNTING ANGLE

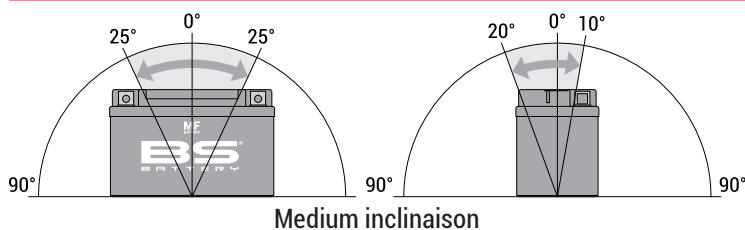

### DIMENSIONS

Length (A) : 150±2mm (5.91in)  
 Width (B) : 66±2mm (2.56in)  
 Container height : 93±2mm (3.66in)  
 Total height (C) : 93±2mm (3.66in)

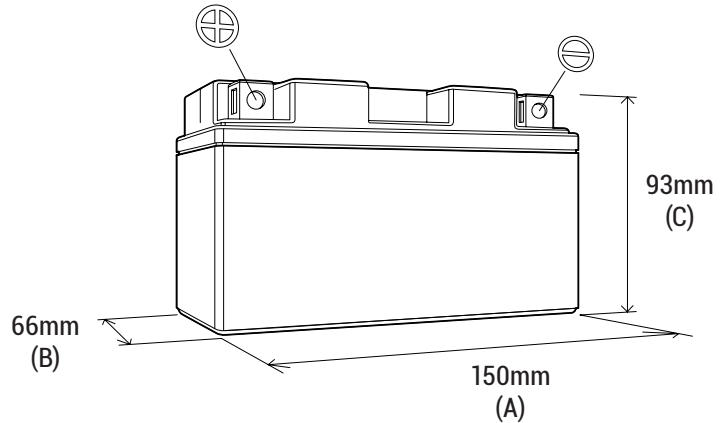

### TERMINALS

